

LIGHT

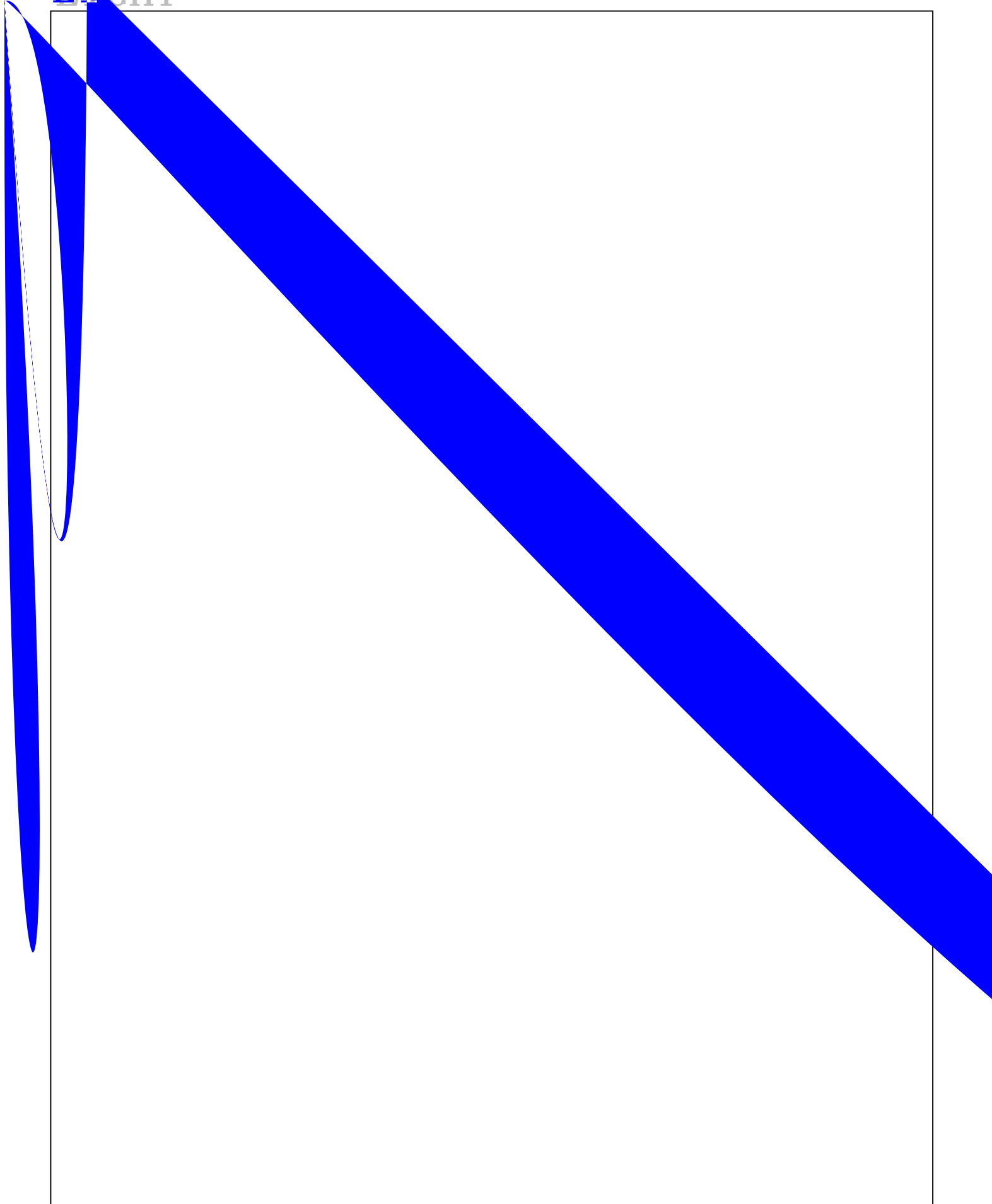

1.

LG-IRM2AB38KSF3

PIN

IC

RoHS REACH

2.

2.7-5.5V

TTL CMOS

3.

(MP3 MP4,)

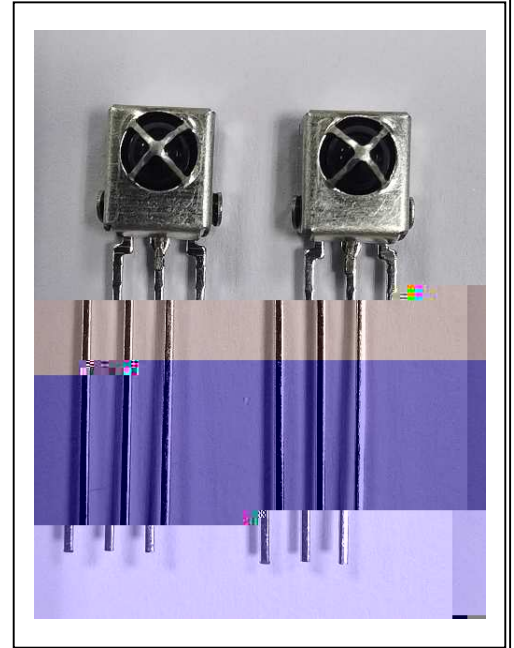

4.

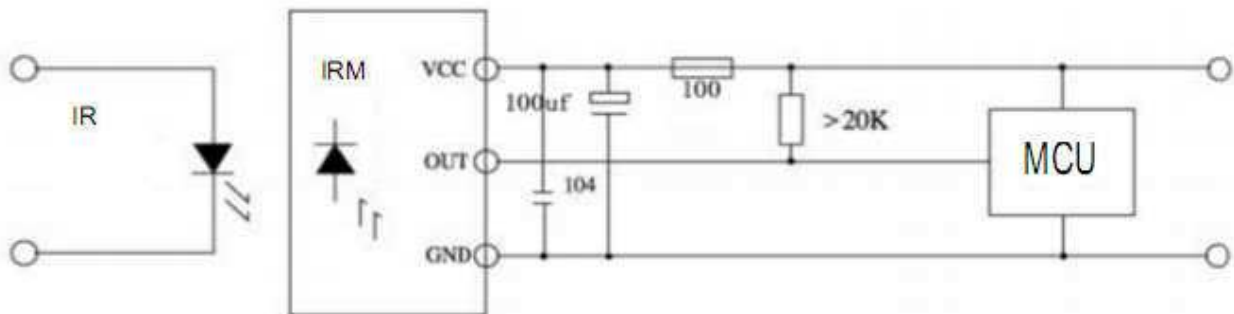

5.

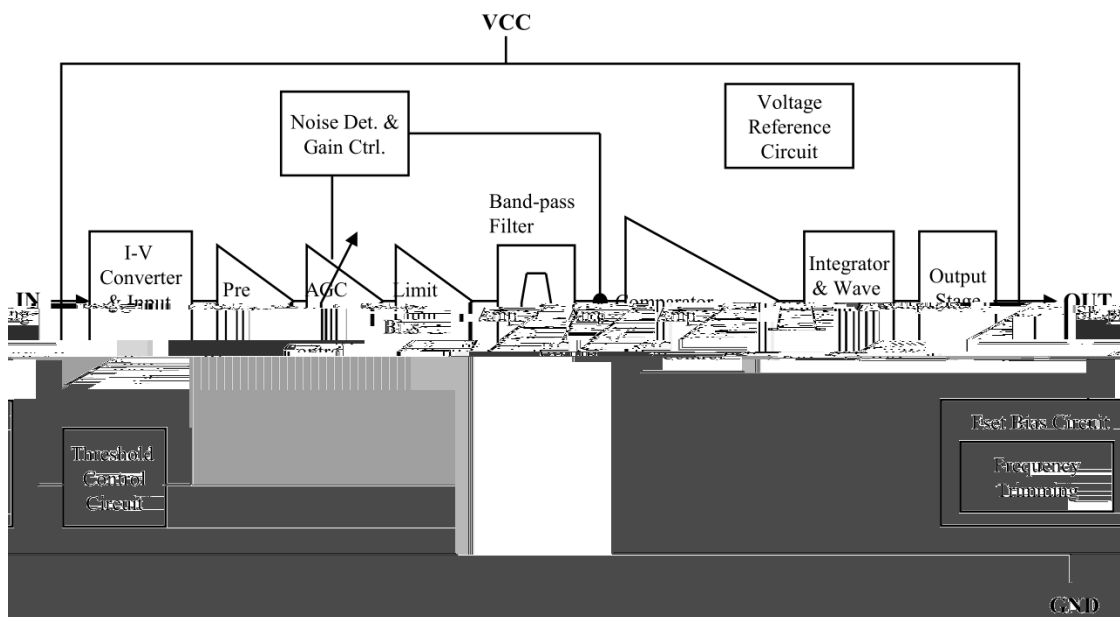

6. (T=25 , Vcc=3.0V, f₀=38kHz)

			Min	Typ	Max	
--	--	--	-----	-----	-----	--

11.

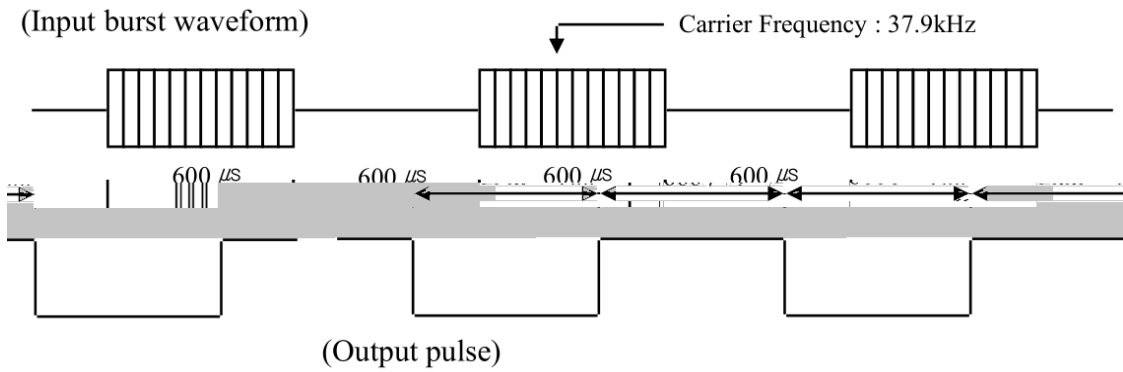

12.

Minimum Burst Length t_{burst} (number of pulses per burst)	10 pulses
Minimum Burst Gap time t_{burst_gap} (number of pulses per burst) between two burst	14 pulses
Minimum data pause time (for full frame repeat code)	< 1 ms

Fig 1. The diagram of min. burst length , min burst gap , data pause time

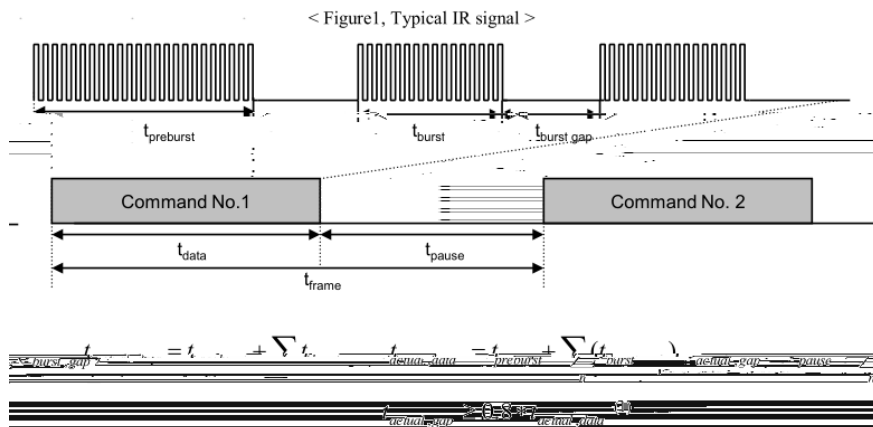

13.

	260 \pm 5	5	20	20
	100PF, 4KV,	---	20	20
	10-50Hz/1min 1.5mm X Y Z/30min	30	20	20
	85 \pm 3	240	20	20
	-20 \pm 3	240	20	20
	85 85%	240	20	20
	-20 30 85 30	10	20	20
	2.5N 2	---	20	20

16.

1

150mm × 190mm

500PCS

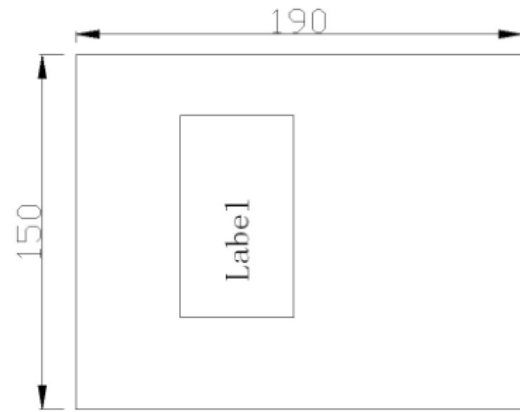

2

500pcs/

10 /

4 /

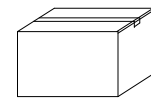
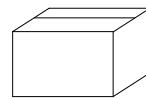
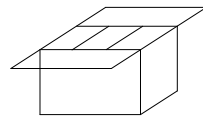
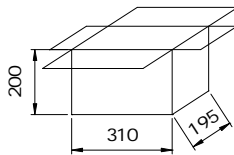

1

2

3

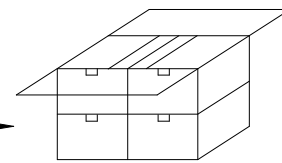
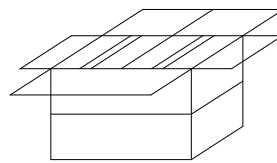
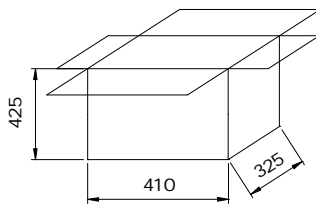

1

2

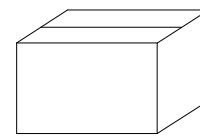
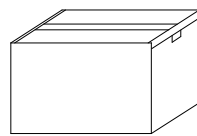

4

3

(pcs /)	(/)	(/)
500	10	4