

13528IRC0219



### Absolute Maximum Ratings at Ta=25

Parameter	MAX.	Unit
Power Dissipation	180	mW
Continuous Forward Current	100	mA
Peak Forward Current <sup>*2</sup>	1000	mA
Reverse Voltage	5	V
Electrostatic Discharge (HBM) <sup>*3</sup>	2000	V
Moisture Sensitivity Level <sup>*1</sup>	5a	
Operating Temperature	-40 to + 85	
Storage Temperature	-40 to + 100	
IR Reflow Temperature	260 for 10 Seconds MAX.	

#### 1. Storage and operating:

(1). Storage requirements before vacuum bag opened: Temperature<30 , HumHBT 0 g BT 08 Tm [(

### Electrical Optical Characteristics at Ta=25

Parameter	Symbol	Min.	Typ.	Max.	Unit	Test Condition
Radiant Intensity	I <sub>e</sub>	1.7	2.0	---	mW/sr	I <sub>F</sub> =20mA (Note 1,3)
	$\theta_{1/2}$	---	120	---	Deg.	(Note 2)
						I <sub>F</sub> =20mA
Spectral Line Half- Width						I <sub>F</sub> =20mA
Forward Voltage	V <sub>F</sub>	---	1.35	1.60	V	I <sub>F</sub> =20mA
Reverse Current	I <sub>R</sub>	---	---	10	μA	V <sub>R</sub> =5V

**Note:**

- Point sources of the amount of radiation per unit time in a given direction within the unit solid Angle radiated energy.  
 $\theta_{1/2}$  is the off-axis angle at which the Radiant Intensity is half the axial Radiant Intensity.
- 
- The I<sub>e</sub> guarantee should be added ±15% tolerance.

**Typical Electrical / Optical Characteristics Curves**  
**(25 Ambient Temperature Unless Otherwise Noted)**

Fig.1 Spectral Distribution

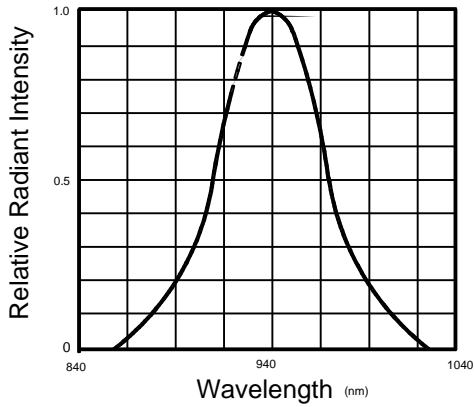

Fig.2 Forward Current Vs Ambient Temperature

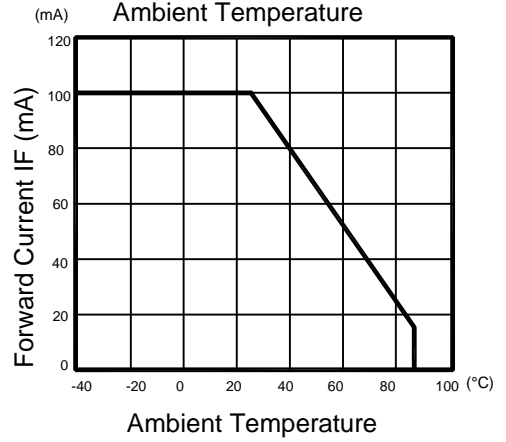

Fig.3 Forward Current Vs Forward Voltage

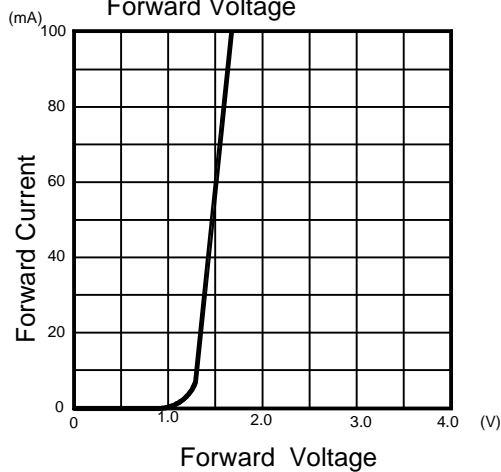

Fig.4 Relative Radiant Intensity Vs Ambient Temperature

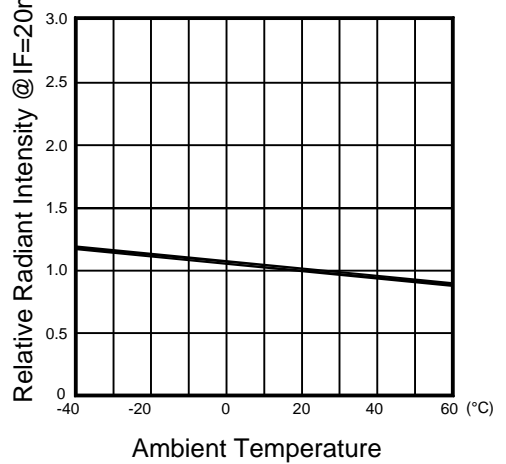

Fig.5 Relative Radiant Intensity Vs Forward Current

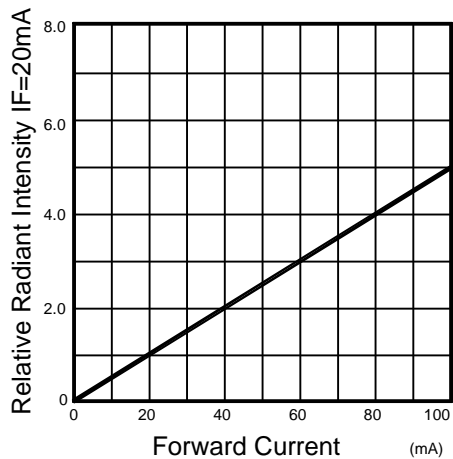
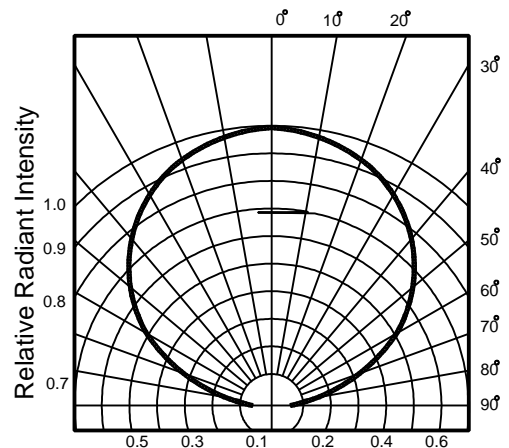

Fig.6 Radiation Diagram



### Radiant Intensity Bin Code ( $I_F=20\text{mA}$ )

BIN CODE	Min.(mW/sr)	Max. (mW/sr)
0	1.7	1.8
1	1.8	2.0
2	2.0	2.3
3	2.3	2.8

**NOTE:** The  $I_e$  guarantee should be added  $\pm 15\%$  tolerance.

**LIGHT ELECTRONICS CO., LTD.**

## Carrier Tape Specifications (Loaded Quantity: 2000pcs/reel)

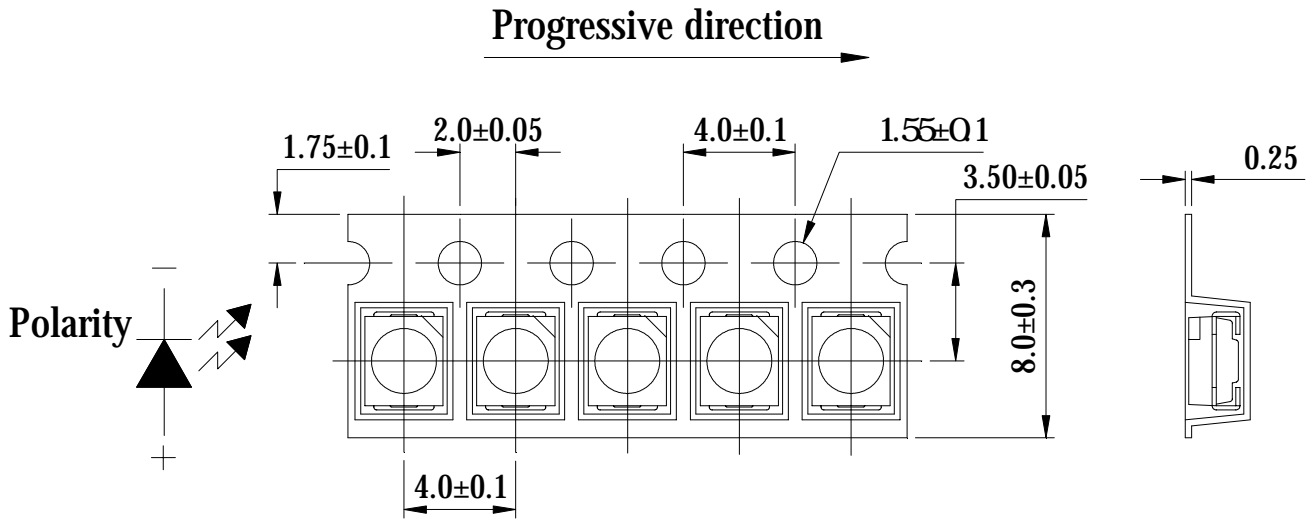

**Note:** Tolerance unless mentioned is  $\pm 0.1$ mm; Unit = mm

## Moisture Resistant Packaging



## Suggest IR Reflow Condition For Lead Free

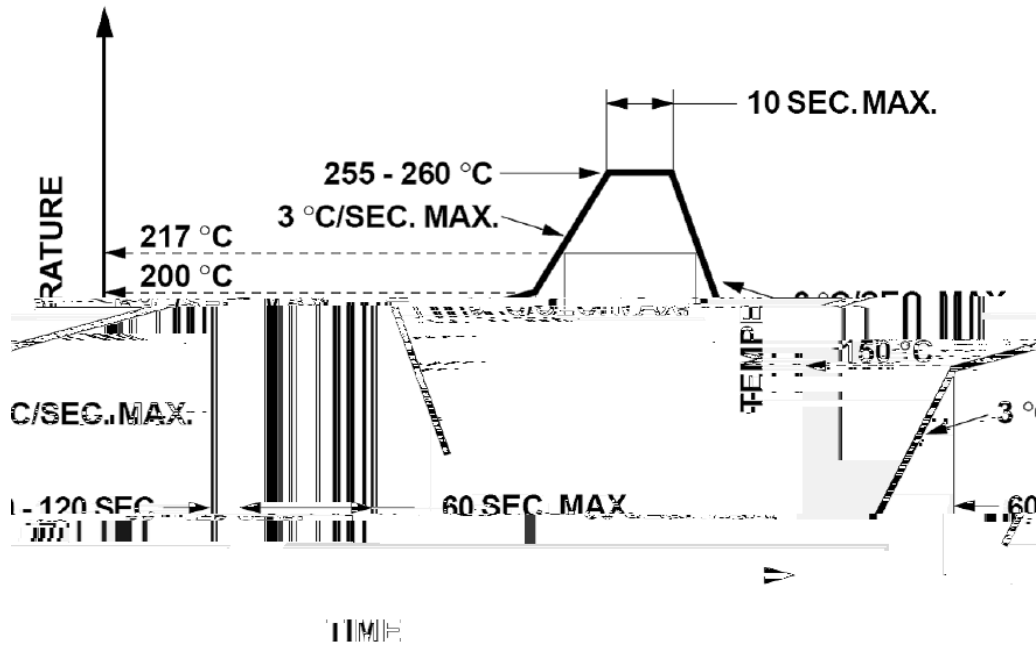

1. Reflow soldering should not be done more than two times.
2. When soldering, do not put stress on the LEDs during heating.

## Soldering iron

1. When hand soldering, the temperature of the iron must less than 300 for 3 seconds.
2. The hand solder should be done only once.

## Repairing

Repair should not be done after the LEDs have been soldered. When repairing is unavoidable, a double-head soldering iron should be used (as below figure). It should be confirmed beforehand whether the characteristics of LEDs will or will not be damaged by repairing.

